

**LEAPERS<sup>®</sup>, INC.**



**OPTICS**  
**USER MANUAL**

**Complete Installation and  
Operating Instructions**

[WWW.LEAPERS.COM](http://WWW.LEAPERS.COM)



## SOLUTIONS FOR ALL YOUR HUNTING AND SHOOTING NEEDS

Innovation, Quality, Value, and Service

**www.leapers.com**  
**32700 Capitol Street**  
**Livonia, MI 48150 U.S.A.**  
**Tel: (734)542-1500**  
**Fax: (734)542-7095**  
**Email: office@leapers.com**

**www.utgeurope.com**  
**Am Bahndamm 7**  
**63683 Ortenberg, Germany**  
**Tel: +49 (0) 6041 – 969686 0**  
**Fax: +49 (0) 6041 – 969686 66**  
**Email: info@utgeurope.com**

A. Scope Components Illustration .....	4
B. Highlighted Features .....	7
C. Scope Ring Installation .....	8
D. Scope Installation .....	9
E. Summary of Reticles .....	10
F. Using the Reticles .....	12
G. Eyepiece Diopter & Locking Ring Adjustment .....	13
H. Battery Installation .....	14
I. Reticle Illumination Adjustment .....	14
J. Magnification Adjustment .....	15
K. Parallax Adjustment .....	15
L. Understanding the Turrets .....	16
M. General Zeroing Instructions .....	21
N. Lens Cap Removal and Installation .....	21
O. Sunshade Installation and Removal .....	21
P. General Care and Maintenance .....	22
Q. Warranty Information .....	22
R. BG4 Reticle .....	23

## A. SCOPE COMPONENTS ILLUSTRATION

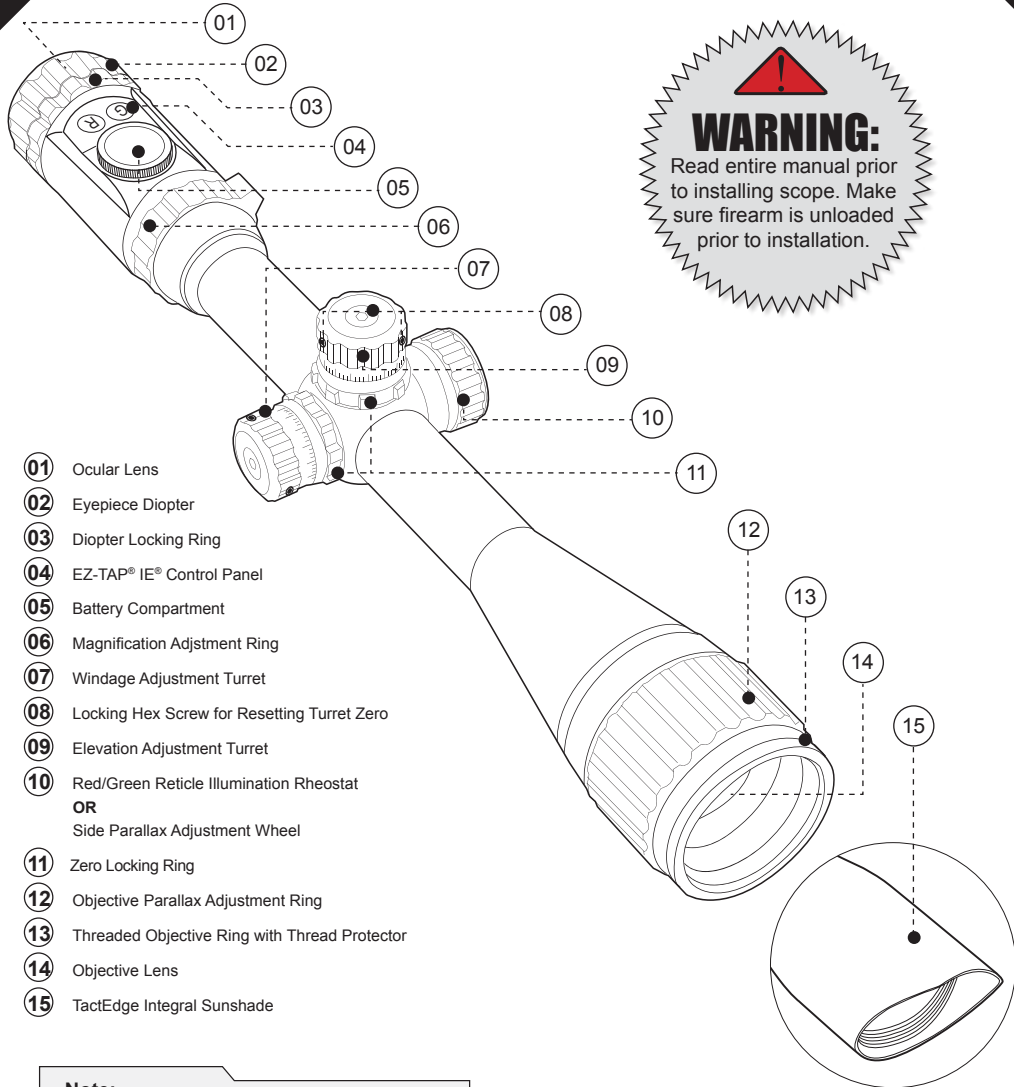

**WARNING:**  
Read entire manual prior to installing scope. Make sure firearm is unloaded prior to installation.

- 01 Ocular Lens
- 02 Eyepiece Diopter
- 03 Diopter Locking Ring
- 04 EZ-TAP® IE® Control Panel
- 05 Battery Compartment
- 06 Magnification Adjustment Ring
- 07 Windage Adjustment Turret
- 08 Locking Hex Screw for Resetting Turret Zero
- 09 Elevation Adjustment Turret
- 10 Red/Green Reticle Illumination Rheostat  
OR  
Side Parallax Adjustment Wheel
- 11 Zero Locking Ring
- 12 Objective Parallax Adjustment Ring
- 13 Threaded Objective Ring with Thread Protector
- 14 Objective Lens
- 15 TactEdge Integral Sunshade

**Note:**

Scope depicted is for illustration purposes and may not represent your actual product and its featured components.

## ACCESSORIES

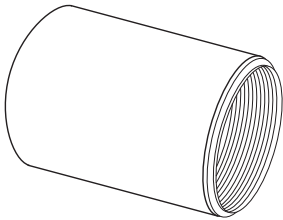

Optional - 3" Sunshade  
(for 44/50/56mm Obj. Dia. Scopes)

Optional - 2.5" Sunshade  
(for 40mm Obj. Dia. Scopes)

Optional - 2" Sunshade  
(for 32mm Obj. Dia. Scopes)



Cleaning Cloth

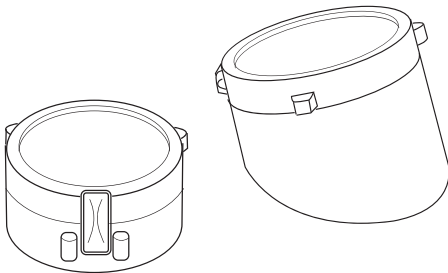

Flip-open Lens Caps  
(Appearance may Vary)

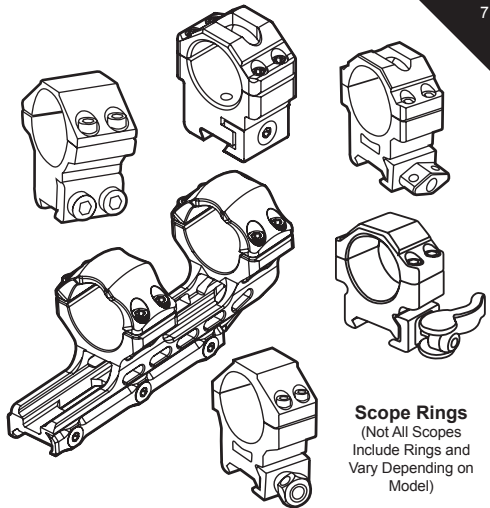

**Scope Rings**  
(Not All Scopes  
Include Rings and  
Vary Depending on  
Model)

## B. HIGHLIGHTED FEATURES

### ► *Signature True Strength™ Platform*

- Completely Sealed and Nitrogen Filled for Shockproof, Fogproof, and Rainproof Performance
- Rugged One-piece Aluminum Main Tube
- Internal Smart Spherical Structure (SSS) simplifies and strengthens the interaction between the inner and outer scope tube for a more responsive, precise, and reliable windage and elevation adjustment and hold
- Disciplined quality control and extensive shock and live fire testing guarantees optimal recoil resistance for long-standing dependability and performance

### ► *Broadband Multi-coated Lenses*

- Individually multi-coated lenses provide a bright and crisp image with a high light transmission rate
- Ensures complete utilization of all available ambient light resulting in higher resolution and clarity

### ► *Quality Precision Machined Components*

- Guarantees reliable, consistent, and accurate performance across the board

### ► *Red/Green Dual Color and or 36-color IE® (Illumination Enhancing) Reticle Options*

- User adjustable reticle color and brightness intensity provides the optimum contrast in various light, weather, and environmental conditions

## C. SCOPE RING INSTALLATION

**CAUTION:** Make sure firearm is unloaded. Remove magazine (if applicable) and examine chamber. Use safe handling procedures at all times.



C-1. QD Lever Lock Scope Rings



C-2. Twist Lock Scope Rings



C-3. Thumb Nut Locking Scope Rings



C-4. Hex Screw Locking Scope Rings



C-5. Torx Screw Locking Scope Rings



C-6. ACCU-SYNC™ Scope Rings & Integral Mounts

### C-1. Mounting QD Lever Lock Scope Rings

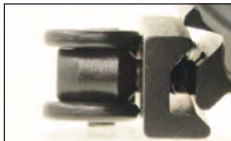

1. Turn the Cam Lever in the direction that widens the spring loaded locking plate and provides the needed mounting clearance for installation. Make sure the QD mount base's cross bolt seats properly within the Picatinny slot.



2. Turn the Cam Lever in the opposite direction to close the spring loaded locking plate, locking the QD mount base to the Picatinny rail.



3. Should the QD mount base be loose, unlock the Cam Lever and use the included Hex Wrench to adjust the Hex Screw found within the Cam Lever Housing. Turning the Hex Screw clockwise will increase the locking plate tension by decreasing the clamping width.



4. Should the Cam Lever not fully turn into the locked position and you feel heavy resistance, the tension is adjusted too high. Use the included Hex Wrench to adjust the Hex Screw counterclockwise to decrease the locking plate tension by increasing the clamping width.



5. The optimal tension is achieved when the locking plate first makes contact with the Picatinny rail while the Cam Lever still has enough travel left for you to turn the Cam Lever to the locked position.

### C-2., C-3. Mounting Twist Lock and Thumb Nut Locking Scope Rings



1. Turn the Twist Lock or Thumb Nut counterclockwise to widen the locking plate and provide the needed mounting clearance to evenly seat onto the Picatinny Rail.
2. Once seated, turn the Twist Lock or Thumb Nut clockwise to tighten. Recommended Torque: 30 in-lbs.

### C-4., C-5. C-6 Mounting Hex/Torx Screw locking Scope Rings



1. Turn the Hex/Torx Screws counterclockwise with the included Hex Wrench/Torx Key Wrench to widen the locking plate and provide the needed mounting clearance to evenly seat onto the Dovetail Rail (For C-4, C-5) or Picatinny Rail (For C-6).
2. For C-4, C-5, if applicable, seat the rings in a position along the rail where the ring's Stop Pin can fully seat and make contact with the Dovetail rail's recessed stop pin holes.
3. Once seated, turn the Hex/Torx Screws clockwise using the included tool to tighten locking plate to 40 in-lbs for C-4, C-5 and 30 in-lbs for C-6.

## D. SCOPE INSTALLATION

(ring style depicted in the following images is for illustration purposes only. Your specific style may vary.)



1. Using the included Hex Wrench/Torx Key Wrench, turn the screws counterclockwise to completely remove the top half of the rings.



2. Place the scope within the scope ring bases, taking care to properly adjust for a comfortable eye relief and that the scope's reticle is leveled.



3. Carefully reinstall the top half of the rings evenly and securely in a cross-torque pattern. Do not exceed over 15 inch-pounds of torque as damages to the scope tube may occur. It is recommended to grasp the Hex Wrench/Torx Key Wrench by it's short end to perform final tightening. The scope is now ready to be zeroed.

## E. SUMMARY OF RETICLES

Leapers offers a variety of reticles for different scopes. See the following reticle information for details pertaining to your specific scope reticle.

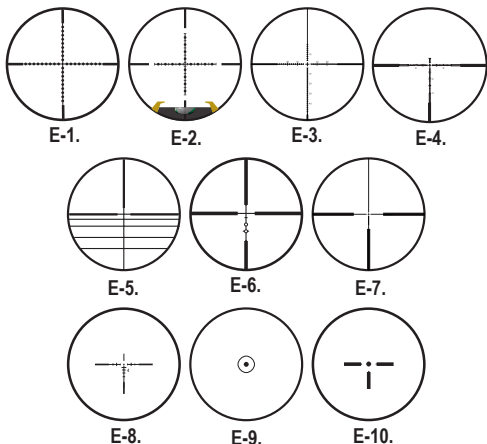

All current UTG scopes have second focal plane reticles. The reticle does not change when magnification is adjusted, but the substensions relative to the target image does. The smaller the magnification, the larger the space the reticle occupies on the target image. All reticles are calibrated at 10x magnification.

**E-1. MIL-DOT RETICLE:** The Mil-dot reticle including wire and etched reticles, is the most widely used reticle on Leapers scopes which provides range estimating capability. The reticle has a big crosshair with multiple dots (or hash marks for greater precision) spread equally apart on its lines in the central area. The distance between two adjacent dots is 1 milliradian.

**E-2. BUBBLE LEVELER EQUIPPED RETICLE:** These include a precision built-in bubble leveling system. The internal bubble leveler is located at the bottom of the field of view for minimal impediment. The purpose of the internal bubble leveler is to ensure consistent orientation of the scope.

**E-3. ETCHED UMOA RETICLE:** The UMOA reticle features hash marks at MOA increments for precise bullet drop and wind drift compensation as well as range estimation. The reticle provides a 4MOA (from end to end) center cross and equally distanced hash marks at 2MOA all the way to 50MOA for hold over, 20MOA for hold under, and 30MOA on each side for wind drift compensation. The center cross can be illuminated to assist aiming under different light conditions.

**E-4. ETCHED TMOA RETICLE:** The TMOA reticle features hash marks at MOA increments for precise bullet drop and wind drift compensation as well as range estimation. The reticle provides a 4MOA (from end to end) center cross and equally distanced hash marks at 2MOA all the way to 40MOA for hold over, 10MOA for hold under, and 30MOA on each side for wind drift compensation. The center cross can be illuminated to assist aiming under different light conditions.

**E-5. PRO 5-STEP RETICLE:** The Pro 5-step reticle is designed for crossbows. The reticle consists of five horizontal lines and a vertical line. There is a thin crosshair in the center. The horizontal lines are for aiming at 10, 20, 30, 40 and 50 yard distances. The lines are calibrated for 300fps crossbows. The user needs to find out the exact yardage of each line using the zeroing procedure on page 13, F-3.

**E-6. PDC RETICLE:** The PDC (Projectile Drop Compensation) reticle of our handgun scope has 3 uniquely shaped marks positioned below the crosshair for ballistic compensation at different yardages. Users can determine the actual Point of Impact at each mark for their particular firearm and cartridge following the zeroing procedure on page 13, F-4.

**E-7. ETCHED G4 RETICLE:** The G4 reticle integrates the classic German #4 design with our innovative 36-color illumination Enhanced (IE®) system. Thick bars at 3, 6, and 9 O'clock positions help the eye quickly locate the center of the reticle, and leave a space of 10 milliradians from left to right allowing a less obstructed view. The fine horizontal and vertical lines along with a ½ MOA center dot at 10X provide the ability for precise aiming whenever needed.

**E-8. ETCHED BG4 RETICLE:** The BG4 Reticle is designed to be fast and intuitive to use and features ballistic drop compensation and rangefinder markings out to 600 yards. The ballistic data is based on common 5.56/.223 loadings in modern sporting rifles. The three thick posts draw the eye to the center for rapid acquisition at close range, while the drop compensation allows for rapid engagement of targets throughout the platform's effective range.

**E-9. ETCHED CIRCLE DOT RETICLE:** The Circle Dot reticle includes a centered floating circle with a dot in its center and is ideally used for shotgun shooting and fly hunting, as well as, tactical applications requiring more emphasis on faster target acquisitions. For an etched circle dot, the typical size is about 1.8 MOA for the dot and 36 MOA for the circle.

**E-10. ETCHED PRECISION T-DOT RETICLE:** The T-dot reticle is ideally used for fast center mass and T-zone aiming applications where getting shots on target quickly is a priority. The reticle consists of a single floating dot in the center as the aiming point with three floating posts arranged at the dot's 3, 6, and 9 O'clock positions. The posts are very quickly picked up by the eye, framing your target, while the single dot provides precision aiming of the area of interest on the target.

## F. USING THE RETICLES

### F-1. Mil-dot Reticle Range Estimating:

- From the center of one dot to the center of the next dot is 1 milliradian (MRAD or 'mil').
- Range estimation requires knowledge of your target's actual width or height. The reticle is calibrated for 10x magnification. If your scope is not at 10x while measuring your target, you will need to convert using the second half of the formula below.
- Measure your target by placing the center of one dot against one edge of the target and measuring to the opposite edge.
- Once the target has been measured in mils, use the formula below to calculate the distance to the target.
- Each mil-dot scope comes with a range card showing the ranging formula and a pre-calculated table to aid the user.



#### Mil-dot Range Estimating Example:

(The formula is for illustration purposes only. For your mil-dot scope, use the formula on your mil-dot card.)

$$\frac{\text{Height or Width of Target in Meters X 1000}}{\text{Height or Width of Target in Mils}} \times \frac{\text{Magnification}}{10} = \text{Range in Meters}$$

For example, when measuring a target known to be 1 meter wide, you see that it occupies 4.5 mils at 9x magnification. Using the above formula, you can tell the target is 200 meters away

### F-2. UMOA/TMOA Reticle Range Estimating:

- From the center of one hash mark to the center of the next hash mark is two Minutes of Angle (MOA).
- Range estimation requires knowledge of your target's actual width or height. The reticle is calibrated for 10x magnification. If your scope is not at 10x while measuring your target, you will need to convert using the second half of the formula below.
- Measure your target by placing the center of one mark against one edge of the target and measuring to the opposite edge.
- Once the target has been measured in MOAs, use the formula below to calculate the distance to the target.

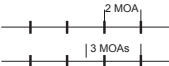

$$\frac{\text{Height or Width of Target in Inches X 100}}{\text{Height or Width of Target in MOAs}} \times \frac{\text{Magnification}}{10} = \text{Range in Yards}$$

For example, when measuring a target known to be 40" wide, you see that it measures 20 MOA at 9x magnification. Using the above formula, you can tell the target is 180 yards away.

### F-3. Using the Pro 5-Step Crossbow Reticle:

Follow the steps below to zero a scope with Pro 5-step Reticle on a crossbow:

This reticle is calibrated for a 300fps crossbow. Due to the differences in crossbows and bolts, we suggest that you confirm the drop yardage with your particular crossbow

- Refer to section M. General Zeroing Procedures, and zero the center crosshair at 10 yards. The second descending crosshair should be accurate at approximately 20 yards, the third at 30 yards, the fourth at 40 yards, and the fifth at 50 yards.
- To confirm, start by moving the target back a further 8 yards and shooting using the next descending crosshair. Adjust the target until the bolt is hitting the bull's eye. Document the exact range.
- Repeat Step 2 for each crosshair.

### F-4. Using the PDC Reticle:

Due to the wide variety of handguns that this scope can be mounted to, the correct bullet drop distances can vary significantly. A .38 Special handgun will show more bullet drop than a .308 Winchester one.

- Refer to section M. General Zeroing Instructions to zero the center crosshair.
- The descending reference points are 2 MOA, 6 MOA, and 10 MOA, with the top of the lower post at 15 MOA below the center crosshair, at full 7x magnification.
- Use the above information to approximate the distances that these holdovers will be accurate for, or alternately use a ballistics calculator.
- For best results, confirm the approximations with live fire testing.

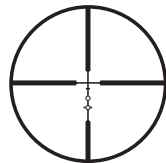

## G. EYEPIECE DIOPTR & LOCKING RING ADJUSTMENT

Fine tunes the sharpness of the reticle to the user's eyesight.

**G-1.** The Diopter adjustment ring is located at the ocular (rear) end of the scope. Point the scope at an uncluttered and light colored background object such as a white wall. Look through the scope and turn the ring clockwise or counterclockwise until the reticle looks the sharpest to you at first glance.



For models with a lockable diopter, turn either the rear eyepiece or eyepiece diopter ring counterclockwise to first unlock it. Next, turn the corresponding locking ring clockwise and away from the rear eyepiece or eyepiece diopter ring to allow room for making adjustments. Lastly, after making your adjustments, turn the locking ring counterclockwise until it is tight against the eyepiece diopter or eyepiece diopter ring to lock it the adjustment in place.



## H. BATTERY INSTALLATION

(For Illuminated Reticle Scopes Only)



H-1. EZ-TAP®

H-2. Fine Adjustment Rheostat

1. The majority of our EZ-TAP® IE® Scopes use a single CR2032 battery. However, there are a select few that use a CR1632 battery. Be sure to use the correct battery type specific to your particular scope. Scopes equipped with a fine adjustment rheostat for red/green illumination use a single CR1620 battery
2. Unscrew and remove battery cap from the housing by turning counter-clockwise
3. Insert correct battery with its + side facing upward while making sure the battery is seated properly within the housing and making full contact with its contact points
4. Screw the battery cap back on until tightened

## I. RETICLE ILLUMINATION ADJUSTMENT

(For Illuminated Reticle Scopes Only)



I-1. Fine Adjustment Rheostat

I-2. EZ-TAP® Console

### I-1 Red/Green fine Adjustment Rheostat

The red and green bands indicate what color the illumination is and their increasing and decreasing widths indicate whether you are at a high level or low level brightness intensity setting respectively. The white dot on the left side of the scope is used as a marker to show where along the rheostat you are. To turn off the illumination, set the white dot to either the "R" or the "G" markers found on the rheostat.

### I-2 IE® Models Illumination Adjustment

#### Turn On/Off

1. Press either the **G** or **R** button to turn on the light.
2. Press and hold either the **G** or **R** button for 1 second to turn off the light.
3. Light will go off after 1 hour with no action.

#### Operating in the RGB Mode

1. Press the **R** button to turn the red light on or to change brightness of the red light.
2. Press the **G** button to turn the green light on or to change brightness of the green light.

#### Switching between RGB and Multi-Color Modes

1. The default mode is the **RGB** mode.
2. To switch between the **RGB** mode and the **Multi-Color** mode, press and hold **BOTH G & R** buttons at the same time for 1 second.

#### Operating in Multi-Color Mode

1. Press the **R** button to change the color between the selections in the Color Index Table.
2. Press the **G** button to change the color intensity as shown in the Color Index Table.



Color Index Table

G Button

Intensity →

Color  
R Button  
Color

Magenta	Thistle	Plum	Violet	Orchid	Purple
Pink	Rosy Brown	Coral	Crimson	Brown	Maroon
Yellow	Khaki	Orange	Golden Rod	Chocolate	Olive
Law Green	Plain Green	Spring Green	Olive Drab	Sea Green	Forest Green
Cyan	Azure	Turquoise	Cadet Blue	Dark Cyan	Teal
Blue	Sky Blue	Dodger Blue	Indigo	Midnight Blue	Navy

#### Memory Feature

When turned on, the illuminated reticle shows the same color and brightness you last used.

## J. MAGNIFICATION ADJUSTMENT

(For Variable Power Scopes Only)

1. For variable power scopes, there is a power ring in front of the eyepiece assembly. To change magnification, turn the ring to align the desired number on the ring with the index dot on the main tube.

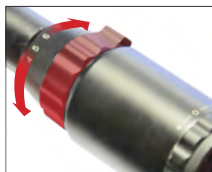

J-1. Adjusting Power Ring

2. The lower power provides wider field of view for quick aiming at close range. The higher power is for precise long-range aiming. When the numbers on the ring are not visible under low light condition, turn the ring left to increase the power, turn the ring right to decrease the power.

## K. PARALLAX ADJUSTMENT

(For Adjustable Objective Scopes Only)



K-1. Front AO Adjustment

K-2. Side Wheel Adjustable Turret (SWAT AO)

K-3. SWAT AO Big Wheel (Optional)

1. Find the appropriate adjustment method from the illustrations above
2. Aim at your target through the scope
3. Adjust your parallax setting to the approximate range of your target, then fine tune the adjustment from there until the target and reticle are in sharp focus



## L. UNDERSTANDING THE TURRETS

The purpose of zeroing the scope is to ensure that the scope's reticle is aligned with the point of impact of the rifle and cartridge. Before zeroing the scope, read the following adjustment instructions carefully.

**Note:** Each click of adjustment for the windage or elevation knob moves the POI (Point of Impact) by the amount shown in the table below:

MOA per Click for Windage/Elevation				
DISTANCE	1/2" Per Click	1/3" Per Click	1/4" Per Click	1/8" Per Click
25 yds	1/8"	1/12"	1/16"	1/32"
35 yds	7/40"	7/60"	7/80"	7/160"
50 yds	1/4"	1/6"	1/8"	1/16"
100 yds	1/2"	1/3"	1/4"	1/8"
200 yds	1"	2/3"	1/2"	1/4"

**Note:** Since climatic conditions such as altitude, temperature, wind and rain can affect trajectory, you may experience some deviation in the exact settings during different shooting sessions.

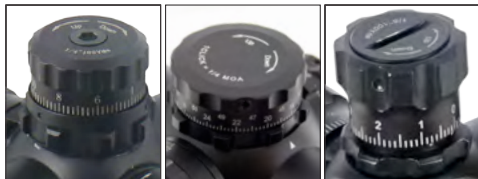

L-1.  
Premium Zero  
Lockable/Reset-  
table Turret

L-2.  
Wide Low Top  
Windage and  
Elevation Turret

L-3.  
High Tower Zero  
Lockable/  
Resettable Turret



L-4.  
TF2+  
Tool-free W/E



L-5.  
True Hunter W/E  
(Turret Color  
May Vary)



L-6.  
Finger  
Adjustable  
W/E



L-7.  
Double Lock Turret  
(Turret Color  
May Vary)

### L-1., L-2 Premium/Wide Low Top W/E Operation

For Models with Premium Zero Lockable/Resettable Target Turrets:

- Both the windage and elevation turrets are set to the locked position out-of-the-box.
- To unlock the windage and elevation turrets rotate the zero locking rings at the base of the turrets counterclockwise about a quarter turn until they stop.



L-1  
Zero Resetting  
Hex Screw      Zero Locking Ring



L-2

#### OPTIONAL: Zero Resetting

Resetting and locking the zero are optional features found on several of our scopes. It allows the shooter to "dial in" adjustments for wind or range, physically lock the turrets in place if desired, and then return to the original zero consistently and easily thereafter.

**Important Note:** In order to maintain the set zero, the Zero Locking Ring must be in the locked position when turning the Zero Resetting Screw loose to disengage W/E.

- Once the scope has been zeroed and the Zero Locking Ring for each turret is in the locked position:
  - For L-1, Turn the Zero Resetting Hex Screw on top of the turret two revolutions counterclockwise. Do not remove the screw completely.
  - For L-2, Turn all three zero Resetting Hex Screws on the side of the knob two revolutions counterclockwise. Do not remove the screws completely.

This will disengage the turrets.

- Once the turrets have been disengaged from the internal adjustment mechanism, rotating them will make no impact to the adjusted zero. Turn the turrets so the '0' marker lines up with the center marker depicted by a white dot or arrow found on the side of each turret.
- Reverse the instructions in step 1 to reengage the turrets with the internal adjustment mechanism.

#### Zero Locking

Once the scope is zeroed, rotate the Zero Locking Rings found on both turrets clockwise until finger tight.

### L-3. High Tower Zero Lockable/Resettable Turret (Bubble Leveler Scope Turret) Operation

1. The windage and elevation High Tower Lockable/Resettable turrets use a coin or screw driver to unlock the zero resetting screw at the top of the turret for zero resetting.

2. Both the windage and elevation turrets are set to the locked position out-of-the-box. To unlock the windage and elevation turrets rotate the zero locking rings at the base of the turrets counterclockwise about quarter turn until they stop.

3. There are horizontal and vertical hash marks beneath the elevation and windage turret that are easy to see and indicate how many rotations you have dialed in after making adjustments beyond your zero. The bottom edge of the turret will reveal a hash mark each time you have made a 1/2 rotation when moving up in elevation or to the right in windage and vice versa.

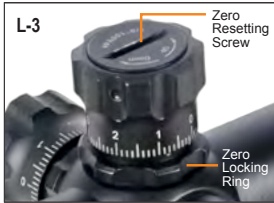

#### Optional: Zero Resetting

Once the scope is zeroed, tighten the locking rings to make sure they are fully locked before proceeding to resetting the zero marker on the windage and elevation turrets.

After zeroing in, the "0" marker may not be facing you at the original center position. You can use the following steps to the reset the "0" marker by rotating the "0" marker to the center position:

1. Use a one coin or screw driver to turn the Zero Resetting Screws on the top of the turrets counterclockwise 180-360 degrees to disengage the W/E turrets. Be sure not to overturn the Zero Resetting Screws. When a turret is "disengaged", the top portion of the turret will freely spin without making any physical adjustments to your zero.
2. Reposition the "0" marker to the center position.
3. Use a coin or screw driver to gently tighten down the Zero Resetting Screws to complete Zero Resetting.

#### ZERO LOCKING

Once satisfied with your zero, simply rotate the Zero Locking Rings at the base of the turrets clockwise until they stop to lock your turrets. Do not over-tighten. When the Zero Locking Rings are tightened, the windage and elevation turrets will not be able to turn, preventing any accidental movement resulting in loss of zero.

### L-4. TF2+ Tool Free W/E Operation

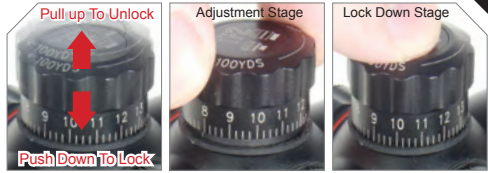

1. The Windage and Elevation Adjustment Knobs have a unique 2-stage Tool-free design. The windage/elevation knobs are in the "locked" mode on a new scope out of the factory. Pulling the knobs upward allows for windage/elevation adjustment.

2. **ZERO LOCKING** (The windage/elevation knobs are in the LOCKED position for a new scope out of the factory.)

When the adjustment knob is pushed down, the knob is "locked" and cannot be rotated. This will prevent any accidental movement to lose zero.

**Note:** To lock an adjustment knob requires proper gear engagement internally. Before pressing the knob down to lock, use minor force to push to get the feel of resistance. If tough to push down, make very slight rotational adjustment (no clicking) to locate the right position to press down. DO NOT force the lock-down.

#### OPTIONAL: Zero Resetting

Once your scope is zeroed, push down both knobs and make sure they are fully locked. The "0" marking may not be facing you at the original center position now. Optionally, you can use the following steps to reset zero by rotating the "0" marking to the center positions:

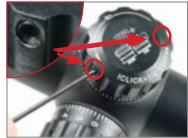

1. Use the Hex Wrench provided to turn both Zero Resetting Hex Screws on the side of the knob counterclockwise for 1 to 2 turns to dis-engage the W/E knobs. When a knob is "dis-engaged", the top cap of the knob can freely spin without ratchet movement. (IMPORTANT: Be gentle with the screw movement. Do not over extend the rotation. Stop when the W/E knob is dis-engaged)
2. When the W/E knob is dis-engaged, rotating the knob will not produce any clicking sound and will not affect zero. You can re-position the "0" marking to the center position. (If you get clicks when rotating the W/E knob, the knob was not properly disengaged. You need to go back and re-start from zeroing your scope before you lock zero and do zero-reset again.)
3. Use the Hex Wrench to gently tighten down the Zero Resetting Hex Screws to complete Zero Resetting. (If you get clicks while tightening the screw, you will need to go back and re-start from zeroing your scope before you lock zero and do zero-reset again.)

## L-5. & L-6. True Hunter/Finger Adjustable W/E Operation WINDAGE/ELEVATION DIALING INSTRUCTION



L-5.

L-6.

Apply gentle force on the rim and dial the knob.

Apply gentle force on the plastic tab and dial the knob.

- Unscrew and remove the cap of the adjustment knob. Put the cap away in a safe place.
- For these two types of scope turrets, no zero locking system exist.
- After the scope being zeroed, make sure to replace both elevation and windage knob caps.

### L-7. Double Lock W/E Operation

1. The Windage and Elevation Adjustment Target Knobs have a unique Locking Screw design. An Hex Wrench is provided with the scope for adjustment.

#### WARNING:

DO NOT over-loosen the locking screws! It may cause the face cover to fall off if screws are backed out too far. If, by mistake, the face lid fell off when you were loosening the screws, please follow instructions below to replace the face cover.

1. Lock both screws down, making sure that they are flush with the surface.
2. Apply a little loctite or similar adhesive on the flat surface of the knob. Make sure that no adhesive gets into the screw holes or onto the screws.
3. Carefully place the face cover back on the knob and align with the locking holes properly. Firmly press the face cover to achieve full contact and wait a few seconds to let the cover adhere to the flat surface of the knob.

**ZERO LOCKING** (The windage/elevation knobs are in the LOCKED position for a new scope out of the factory.)

1. Unscrew and remove the cap of the adjustment knob. Put the cap away in a safe place. Gently dial the knob and test if it is locked. If not, you can skip section ii.
2. To Unlock: Locate the two locking screws as shown on the right. Use the included small Hex Wrench to unlock both locking screws by turning them counterclockwise 1/4 revolution.
3. To Lock: Use the included small Hex Wrench to fully lock down both screws by turning them clockwise. It is recommended that you gradually lock both screws alternately until they are fully and evenly locked.



- Unscrew and remove the cap of the adjustment knob. Put the cap away in a safe place.
- After the scope being zeroed, make sure to replace both elevation and windage knob caps.

## M. GENERAL ZEROING INSTRUCTIONS

Ensure that the turrets are unlocked before performing this process, if applicable.

1. We recommend initial zeroing using a bore sighter if one is available. Follow the instructions that came with the device.
2. Place target at preferred zero distance. Stabilize application with a bench vise, sandbag, bipod, or similar device. Set scope to the highest magnification in order to aim as precisely as possible.
3. Fire a 3-shot group.
4. If the average Point of Impact (POI) is the same as the Point of Aim (POA), the scope is zeroed. If not, adjust the scope according to the table opposite to bring the POI to the POA. The markings on the turret denote the direction the POI will move on the target.
5. Repeat steps 3 and 4 until the POA is the POI.
6. Many of our scopes have zero locking and/or zero resetting turrets. It allows the shooter to "dial in" adjustments for wind or range, physically lock the turrets in place if desired, and then return to the original zero consistently and easily thereafter. See the appropriate sections under **L. Understanding the Turrets** for specific instructions.

## N. LENS CAP REMOVAL AND INSTALLATION

1. To remove, simply grab the non-hinged side of the lens cap and carefully pull the lens cap away from the scope while keeping the scope secured in the other hand.
2. To install, if applicable, line up the guiding grooves found on the inside of the lens cap with that of the scope's outer grooves and push the lens cap onto the scope while keeping the scope secured in the other hand. Keep in mind, the orientation of the cap's hinge and how you would prefer the lens cap to swing into the open position
  - If your lens cap does not have guiding grooves, simply push the lens cap onto the scope while keeping the above orientation in mind



## O. SUNSHADE INSTALLATION AND REMOVAL (For Scopes with Detachable Sunshade Only)

1. Remove the lens cap from the objective lens.
2. Unscrew the objective lens's thread protector by unscrewing it counterclockwise. (Not all models have a thread protector. Skip this step if not applicable)
3. Screw on the correctly compatible sunshade to the front of the objective lens by threading the sunshade clockwise until tightened and fully secured.
4. Screw the objective lens's thread protector onto the front of the now installed sunshade. (Skip this step if not applicable)



## P. GENERAL CARE AND MAINTENANCE

1. Take care not to drop or knock the scope once it is zeroed.
2. Keep the protective lens covers in place when the scope is not being used.
3. Maintain the metal surface of the scope by removing any dirt or sand with a soft brush so as to avoid scratching the finish.
4. Wipe the lens with a clean flannel cloth to keep it clean and dry. In order to avoid scratching the glass, ensure both the lens and cloth are clean. Do not use finger or finger nail to touch/clean lenses.
5. Store the scope in a cool dry place when not in use. Be careful to avoid contact with acid, alkaline or corrosive chemicals. Remove battery if the scope is being stored away for an extended period of time.
6. Do not attempt to lubricate any part of the scope.
7. Do not disassemble the scope. Any such action will void the warranty.

**CAUTION** Viewing the sun can cause serious eye injury. Never look directly into the sun with this or any scope.

## Q. WARRANTY INFORMATION

### The Best Never Rest Warranty - Lifetime

Leapers, Inc. warrants that all UTG products conform to published specifications and are free from defects in material and workmanship. We will repair or replace defective products for the duration of the product's life span. Our dedicated in-house customer service professionals will provide the best-in-class UTG experience -

#### NOTES:

Our warranty does not extend to products disassembled, damaged from misuse, accidental impact, negligence, natural disasters/accidents, or unauthorized repair or alteration.

#### Warranty Instructions

You can either contact the store where the product was purchased OR get in contact with us on [www.leapers.com](http://www.leapers.com).

To submit a warranty case, please follow the following steps:

1. Go to Warranty Request under Customer Service on [www.leapers.com](http://www.leapers.com).
2. Fill out the necessary contact and product information to the best of your knowledge.
3. A purchase receipt is required for all warranty cases and needs to be attached at the end of the form.
4. Finalize the case by submitting the information to us.
5. You will hear from one of our customer service reps within 24-48 hours and we will provide you with additional information and instructions.

For any questions regarding the process, please feel free to call us at (734)542-1500 or email us at [office@leapers.com](mailto:office@leapers.com)

## R. BG4 RETICLE

(Subtension diagram- subtensions are only valid at fully 8X magnification)

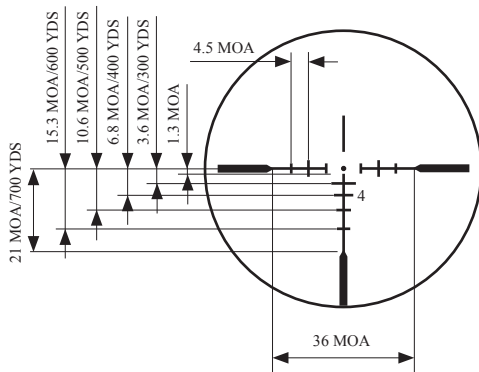

## Zeroing the Reticle

The BG4 Ballistic Drop Compensating Reticle is designed to match the typical combination of 5.56mm/.223 cal loadings and modern sporting rifles. The center dot (A) is intended to be zeroed at 100 yards for the remaining bullet drop reference points to work as intended. As an alternative for short range zeroing, the 300 yard point (C) can be used to zero at 25 yards. If this is done, we recommend confirming the zero at 100 yards at the first opportunity. Otherwise, use the instructions for zeroing found in Section K of the user manual.

## Using the BG4 for Bullet Drop

The BG4 reticle provides seven Points of Aim (POA) corresponding to Points of Impact (POI) from 100-700 yards. See the reticle diagram in the next section and the chart below:

POA	A	B	C	D	E	F	G
POI (yards)	100	200	300	400	500	600	700

All of these correspond to the optic at full 8X magnification, and may be approximates for your loading/rifle combination and prevailing climate. Please see the subtension diagram on the back and your ballistics calculator for more precise values.

## Using the BG4 for Range finding

The BG4 reticle provides multiple points to approximate range to an 18" wide target, which is commonly used in various competition shooting disciplines.

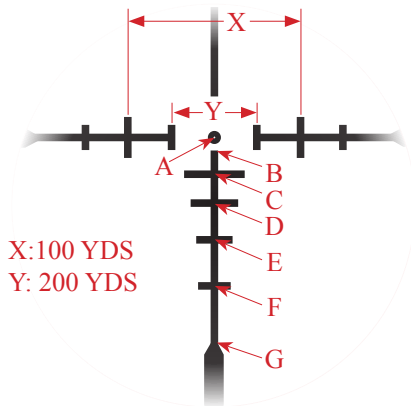

If an 18" target fits between the bars marked X, the target is approximately 100 yards away and you should use POA A. If it fits between the bars marked Y, it is approximately 200 yards away and you should use POA B. The bars for the remaining POA's correspond to an 18" target at their respective ranges.

Leapers, Inc., headquartered in Michigan, U.S.A., has been in the business of supplying shooting, hunting and outdoor gear since 1992. We set un-compromised high standards for all of our business operations. Our goal is to provide a total solution for any line of products we offer. We pay close attention to industry trends and customer feedback, with a focus on making the best-in-class niche products available for hunting, shooting and outdoor enthusiasts like you.

# EXPLORE MORE AT

[WWW.LEAPERS.COM](http://WWW.LEAPERS.COM)



[www.LEAPERS.com](http://www.LEAPERS.com)  
32700 Capitol Street  
Livonia, MI 48150 U.S.A.

Tel: (734) 542-1500

Fax: (734) 542-7095

Email: [office@leapers.com](mailto:office@leapers.com)